

Mitsubishi Electric Hand Dryer

Safety Precautions

For Installers

- Safety Precautions**
- Read the manual thoroughly before beginning installation to ensure the appliance is installed safely and correctly.
 - Local installation standards should be obeyed and installation should be performed by the dealer or a qualified professional.
 - Do not install in locations where salt damage may occur, or where corrosive, neutral, or reductive gases are present.
 - Do not scratch, damage, process, excessively bend, pull, twist or bundle the power cable, and do not place heavy objects onto it or trap it.
 - Do not attempt any disassembly or modification of the appliance that is not expressly stated in the manual.
 - Do not use in a hot location such as a shower room, where condensation may form on the appliance, or where water may splash directly onto the appliance.
 - Electrical wiring work should be done by a certified professional in conformance with the technical standards for the equipment or official standards.
 - Use single-phase 220-240V power.
 - Use exclusive wiring.
 - Be sure to install a ground-fault circuit interrupter.
 - A means for disconnection must be incorporated in the fixed wiring in accordance with the wiring rules.
 - Do not install when the product (power cable) is electrified.
 - Install securely in a location strong enough to support the weight of the appliance.
 - Wear gloves when installing the appliance.

For Users

- Safety Precautions**
- Read the manual thoroughly before use to ensure the appliance is used safely and correctly.
 - Do not open the front panel.
 - Do not use at locations where salt damage may occur, or where corrosive, neutral, or reductive gases are present.
 - Do not use in a shower room or other locations with a great deal of humidity in the air, or where condensation may form on the appliance.
 - Do not allow water to get on the appliance.
 - Do not modify or disassemble the appliance.
 - When changing the installation place, consult your dealer or installer.
 - Use single-phase 220-240V power.
 - Use exclusive wiring.
 - Always turn off the power switch during maintenance work.
 - This appliance is not intended for use by young children or infirm persons unless they are adequately supervised by a responsible person to ensure that they can use the appliance safely.
 - Young children should be supervised to ensure that they do not play with the appliance.
 - Do not use for drying anything other than hands.
 - Wear rubber gloves when cleaning the appliance.
 - Always use the appliance with the drain tank, air filter, and side covers attached.
 - If the appliance stops working or if a malfunction occurs, turn off the power switch and groundfault circuit interrupter before contacting your dealer for an inspection and repairs.

Installation Precautions

- Do not install in the following types of location.**
1. Outdoors
 2. Locations where the temperature could be lower than 0°C.
 3. Locations where there is a lot of dust.
 4. Locations where the temperature could be higher than 40°C.
 5. Locations where there is a lot of condensation.
 6. Locations where salt damage may occur.
 7. Vehicles (including ships and airplanes)
 8. Locations where the appliance is in direct or strong sunlight
 9. Near food or tableware.
 10. Locations where the appliance may come into direct contact with water.
 11. Kitchens (Where there is a risk of water splashing.)
 12. Locations where corrosive, neutral, or reductive gases are present.
 13. Rooms that have a sterilization basin, swimming pools, bathrooms.
- Ensure a distance of at least 130mm from the floor. Failure to do so may result in dirt or water entering the appliance, causing damage.
 - Ensure there is at least 150mm on both sides of the appliance to allow for maintenance.

Caution

- Drying time (listed in the catalogue) will vary by individual user.
- Continuous operation in high-temperature environments (40°C) may cause overheating to be detected in electronic components, with an error indication appearing. This does not mean that the unit has malfunctioned, with the error sign automatically terminated when the temperature declines.
- Do not use the product to dry any chemicals or similar substances from the hands; failure to observe this precaution may shorten product life.
- Because the product is an electrical appliance, it should not be cleaned directly with pressurised water or by similar means.
- Do not clean the front cover of a silver appliance with alcohol.
- *Alcohol* means a disinfectant with an ethanol content of 83% or less.
- Do not use any of the following cleaning materials
 - Solvents such as thinner or benzene
 - Acid, alkaline or chlorine detergents
 - Mold and mildew removers
 - Citrus-based or other plant-based detergents
 - Nylon scourers or abrasives
 - Antiseptics
- Damage to the appliance (such as rusting) is not covered by the warranty if the above cautions are not observed.
- To clean the exterior of the main unit, remove any dust or grime using a damp cloth. If using a detergent, use only a neutral detergent diluted with water (pH: 6-8)
- After cleaning with neutral detergent or alcohol, be sure to wipe away all remaining traces of the detergent or alcohol.
- Water collected in the tank and drain receptacle at the bottom of the main unit must be emptied regularly to avoid overflow.
- Clean the air filter approximately once a week.
- Jet Towel service life is about 7 years, figured at 400 uses daily. Depending upon specific use conditions, this period may be shortened. Please contact Mitsubishi Electric if daily use broadly exceeds the designed level. In cases when the number of uses doubles the average frequency, for example, the unit's lifespan will be reduced to one-half.
- Water drawn into the main unit may be absorbed by the soundproofing material, resulting in bacterial build-up. To prevent this, ensure that water does not get in around the air filter and air intake.

Note

- Do not use with chemicals on your hands.
- Be sure to completely wipe off any detergents or chemicals on the appliance.
- Only use the specified cleaning agents.
- If water is sucked into the appliance, it may cause damage to the mechanism, or moisture may be absorbed into the soundproofing material, allowing bacteria to breed. Therefore, do not allow water to come in contact with the air filter or air duct.

*Safety considerations require that the serial number and/or appropriate markings or labeling be visible. When purchasing the product, make sure they are displayed on the main unit.

- Certain ratings and specifications may change due to product improvements or modifications.
- While every effort has been made to represent product colours herein accurately, slight deviations from actual colour may be noted due to the printing process.



Mitsubishi Electric Corporation's Nakatsugawa Works is an ISO certified plant, having obtained both ISO 9001 Quality Management System and ISO 14001 Environmental Management System certification.

Mitsubishi Electric Hand Dryer website http://www.wfai.wzngcbwja_

[MITSUBISHI ELECTRIC Regional Branch]

miscea GmbH
 Hauptstraße 2
 14979 Großbeeren
 Germany

 T: +49 (0) 33701 3553 - 0
 F: +49 (0) 33701 3553 - 19

 E: berlin@miscea.com

MITSUBISHI ELECTRIC CORPORATION
 HEAD OFFICE : TOKYO BLDG., 2-7-3, MARUNOUCHI, CHIYODA-KU, TOKYO 100-8310, JAPAN

For Europe

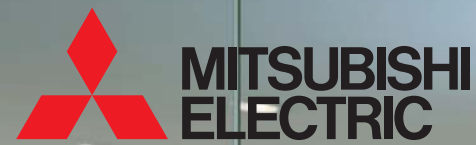

HAND DRYER

Changes for the Better

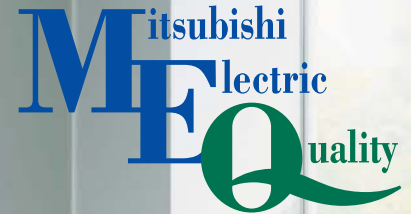

Jet Towel



The Best Choice For Fast Hand Drying
 and Low Power Consumption

for a greener tomorrow



<http://www.mitsubishielectric.com/bu/handdryer/>

JET TOWEL

a Mitsubishi Electric original

Hand Drying for the 21st century



Since developing the world's first jet towel in 1993, we have continued to improve technologies and services focusing on ease of use for our customers.



For the Environment

No Waste Paper

The high-speed Jet Towel™ hand dryer uses jet streams of air to dry hands, eliminating the paper waste associated with the use of paper towels, and thus relieving you of the trouble of waste disposal as well. The preservation of forest resources will also contribute to enhancing your corporate image.



*Many paper towels are made from recycled paper, so it does not necessarily lead to environmental destruction.



For Corporate Management

Substantial Cost Reduction

The monthly expense is reduced to a fraction of the cost in comparison to paper towels or rolled-cloth towels. The higher the use, the greater the savings.

Visit the website below to run a cost simulation
<http://www.mitsubishielectric.com/bu/handdryer/>

Uses per day	100 uses	200 uses	300 uses	400 uses
Paper towels	5000	10000	15000	20000
Cloth-roll towels	7500	15000	22500	30000
JT-SB216JSH	Heater on	196	376	557
	Heater off	130	246	361
JT-SB216KSN		127	239	351

Unit: ¥

Calculation conditions
 *Used 25 days per month
 Jet Towel: Heater on for 10sec., off for 11sec. per use; Constantly on (1 day = 24hr; 1mo = 30d); Electricity cost of (¥) 21 yen/kWh
 Paper towels: Paper cost of (¥) 1 yen per sheet; 2 sheets per use
 Cloth-roll towels: Rental fee of (¥) 600 yen per roll; 200 uses per roll



For Building Management

Easy Maintenance

Appealing to building management companies too! The only maintenance required is clean the air filter and removing water from the drain tank*. Save time by eliminating the daily replenishment of paper towels, disposal of paper waste and replacing rolled-cloth towels.



For Customers

Improved Service

Evaluated highly for its sanitary characteristics, the Jet Towel™ is popular among facilities and shops alike. In addition to its ability to dry hands completely in a matter of seconds and offer a clean sanitary environment for customers, maintenance and upkeep costs are minimized for maximum cost efficiency. The result, enhanced customer service.



Overflowing with Innovations Unique Only to Mitsubishi Electric... Jet Towel™ Technologies

Simple to Use

Easy hand access from both sides.

Open-side Design

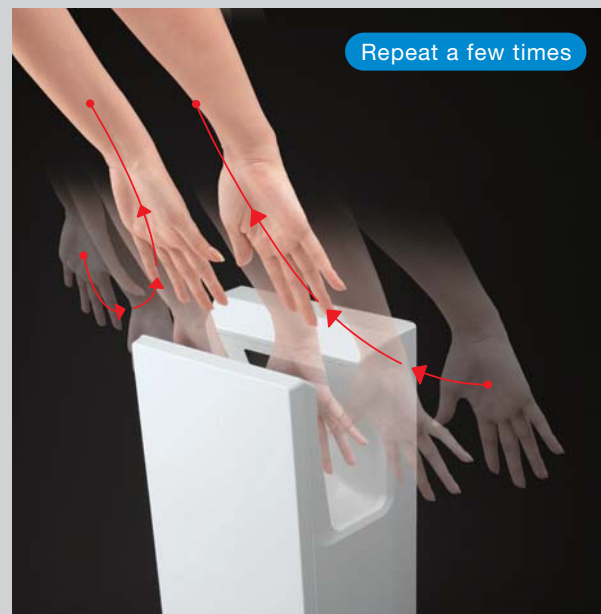

The dryer is open on both sides, enabling easy hand access from the side without touching the unit. Inserting hands from the sides as shown in the photo, and slowly raising and lowering them a few times maximizes drying performance.

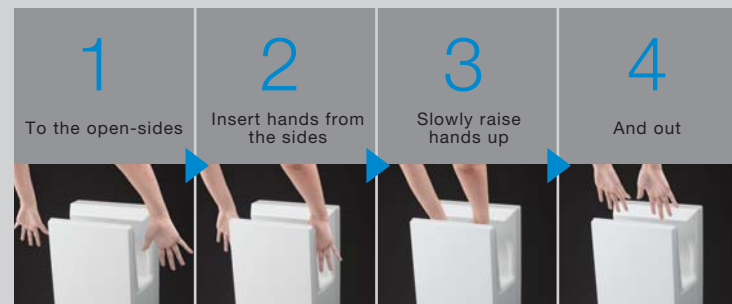

Repeat 1 to 4 a few times.

Highly reliable start and stop.

Upper and Lower Sensor Operation

For smooth and reliable operation, the dryer is equipped with upper and lower sensors. Once hands are fully inside, lower sensor detection starts the airflow, and when hands are removed completely, upper sensor detection stops the dryer, preventing water drops from blowing back up. The New Slim Type is equipped with a "Child Sensor*" further enhancing operation ease.



Start detection sensor is located in the lower side of the trough.

Easy to use in natural posture.

Comfortable Positioning

Development included studying a hand insertion angle comfortable and easy to use for a majority of people. As the result, the front panel is gently slanted outward, creating an ergonomic hand insertion angle of approximately 15° that allow users to stand comfortably and naturally when inserting their hands into the trough.



Hygienic

Bacterial growth suppressed for all parts susceptible to contact with water.

Antibacterial Treatment

All parts susceptible to coming in contact with water, such as hand-drying section, drain tank and water drainage duct (drain hose), are subjected to antibacterial treatment to ensure highly sanitary conditions.

*Blue-shaded areas have received antibacterial treatment.

<Comparative Proof of Antibacterial Effect>
Following 24hr culturing using film contact method in Mitsubishi Electric laboratories.

Bacteria accumulation

w/o antibacterial treatment

w/ antibacterial treatment

Silver ions attach to the cell walls of general cellular bacteria, curbing protein synthesis and reactions to control bacterial growth and reproduction.

Independent air ducts ensure airflow is always fresh.

Independent Air Ducts

In addition to an extremely hygienic touch-free design, emphasis has also been placed on ensuring the flow of fresh-air. The air-intake port and airflow route are isolated from the water drainage duct in Mitsubishi Electric products. Inserting the hands triggers a jet-stream of fresh air without using any air in the vicinity of the hands.

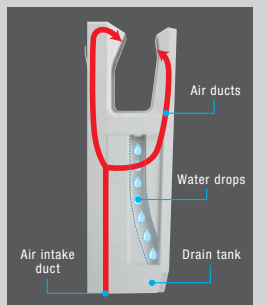

Can be wiped clean with alcohol.

Alcohol-resistant Resin

An alcohol-resistant resin is used, enabling alcohol-based products to be used for cleaning the hand-drying section, drain tank and water drainage duct where sanitary conditions are a matter of concern. The open-side design, which allows easy hand access from either side, ensures quick and thorough cleaning of the hand-drying section as well.



*"Alcohol" means a disinfectant containing 83% of ethanol or less.

Comfort

Choice of operation modes according to use

Air-speed and Heater Setting Switches Included

There is a choice of two airflow speeds: "High" for prioritized drying and "Standard" for low-noise operation. The heater can be switched on or off.

*The setting switches are located inside the main unit, and can only be set at the time of installation.

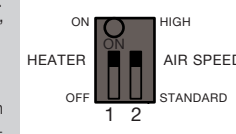

Mode	Drying time	Operating noise*	Power consumption
HIGH	Approx. 9~11sec.	Approx. 61dB	1240W
STANDARD	Approx. 11~13sec.	Approx. 58dB	1070W

*JT-SB216JSH used with heater turned on and at factory default settings. Measurements performed in an anechoic chamber at a distance of 2m.

Stable operation for long service life.

Brushless DC Motor

400 uses daily
service life
Approx. 7 years

The motor is a key part of the Jet Towel™. Accordingly, Mitsubishi Electric has developed a durable, high-quality brushless DC motor (Slim Series) designed for use 400 times a day for seven years. Eliminating problems related to the wear-and-tear on motor brushes ensures truly efficient power and stable operation for extended periods of time.

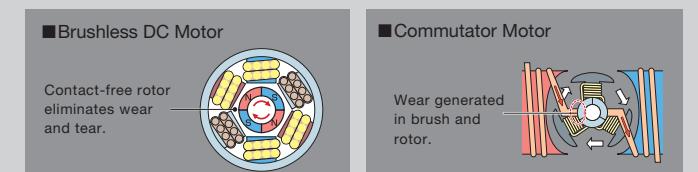

Refined, Ergonomic Design Available in Three Attractive Colors
 - Select the unit that best matches your sanitary needs

New Slim Series

Heater Type

Model JT-SB216JSH (w/heater) 220-240V/50•60Hz (-W White, -H: Dark Gray, -S: Silver)

Heater-less Type

Model JT-SB216KSN (w/o heater) 220-240V/50•60Hz (-W White)

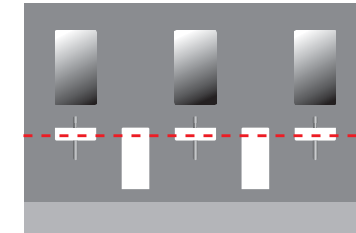

Install multiple units neatly aligned with sinks.

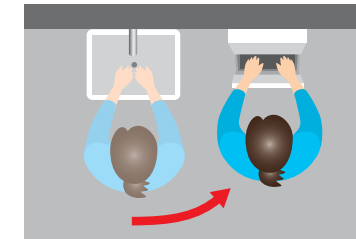

Prevent water from dripping onto the floor for better impression of cleanliness.

Designed for Installation between Sinks Can be aligned with the top of sink basins.

The ergonomic rectangular design matches well with most sink styles. Overall unit size was taken into consideration as well, ensuring that the top of the unit can be neatly aligned with the top of the sink basin. To ease congestion and prevent water spillage, the installation of multiple units is recommended for places frequented by many people such as movie theaters and amusement facilities where many may use dryers at the same time.

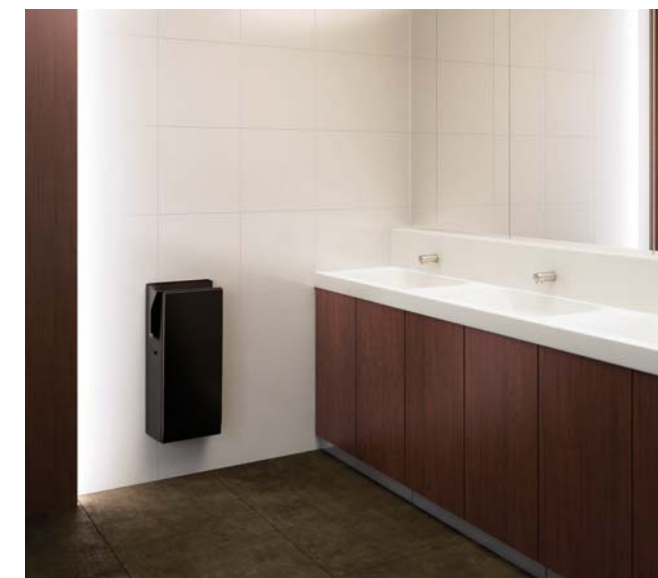

*Counter table Installations or alignment with sink basin tops may result in an installation height lower than that recommended.



Silver: luxurious and chic



White: clean and hygienic

JT-SB216KSN (without heater)	JT-SB216JSH	(see page 4 for details)	(see page 4 for details)	(see page 4 for details)			JT-SB216JSH	

*1: Airflow rate is measured at the nozzle outlet. *2: "Alcohol" means a disinfectant containing 83% of ethanol or less. *3: Standard Mode.

Choose from a Variety of Colors Units blend easily into any décor.

In addition to highly popular White, a variety of new colors are now available. Two-toned Dark Gray and Silver, having a dark-gray body and silver front panel; a chic Dark Gray that is ideal for tranquil restaurant atmospheres and the like; and stylish Silver for upper-class hotels and similar venues. The extended color line-up offers greater flexibility in color coordination and installation applications.

Advanced in Every Aspect for Greater Ease of Use by All

New Slim Series

1 Thorough High-speed Drying, Low-noise Operation and Saves Energy

World-first technology introduced by Mitsubishi Electric in 1993 Dual Jet Airflow

Industry top-class drying performance

Mitsubishi Electric's proven Dual Jet engineering is now complemented with a streamlined nozzle design that provides an optimum balance between airflow rate and air volume, further enhancing efficiency and drying hands in a matter of seconds.

*1: JT-SB216JSH (High, Heater ON)
*2: JT-SB216ESH (Heater ON)

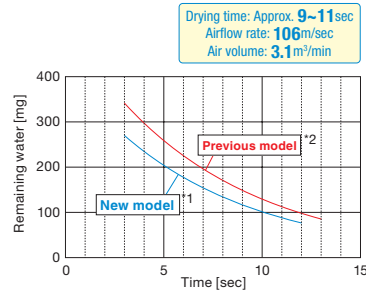

Increased comfort with 1dB noise reduction (compared to previous model*)

Wave-shaped Nozzles

Innovative wave-shaped nozzles are introduced, reducing the amount of noise generated by the airflow dispersed from the jets. Coupled with an original fluid-control technology, extremely efficient low-noise operation has been achieved.



<Previous model>

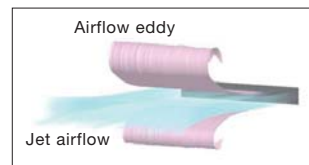

Eddy generated with straight nozzle outlet flows easily, becoming a source of noise.

<New model>

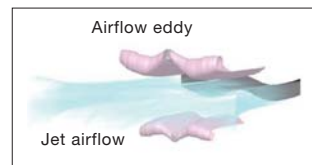

Eddy generated with curved nozzle outlet. Less eddy generated, resulting in quieter operation.

Leading the industry with Dual Jet drying

Industry's Lowest Power Consumption

Further energy savings based on the lowest power consumption in the industry*1 achieved through a 2%*2 reduction in power consumption and standby power reduced approx. 50% compared to previous models.

*1: For two-way jet airflow hand dryers. Applies to model with no heater (JT-SB216KSN).

*2: Comparison of previous model, JT-SB216GSN, and new model, JT-SB216KSN.

2 User-friendly Design for All Ages

Freer range of hand movement

Spacious Hand-drying Zone

Area increased
Approx. 1.4 times

The volumetric area of the hand-drying section has been increased approx. 1.4 times (to 6.8L from 5L of our previous model*). The more spacious touch-free design increases the hygienic value of the unit and ensures improved user ease for people with large hands.

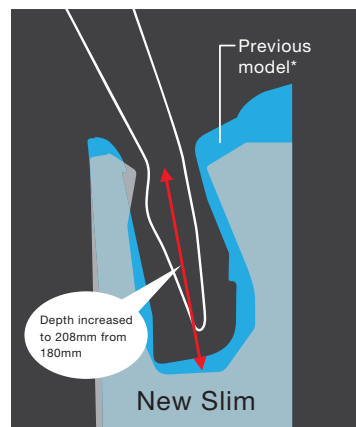

*JT-SB216ESH/GSN

Easy for small children to use

Child-conscious Design

For younger children,*1 who are not so tall, the upper part of the front panel has been lowered and a "Child Sensor" added to the upper hand-drying section to ensure detection of small hands. Even if hands cannot reach deep inside, this sensor will detect them and start/stop unit accordingly. Additionally, expanding on the original open-side design, children too can use the unit to dry their hands while standing at a relaxing, normal posture.

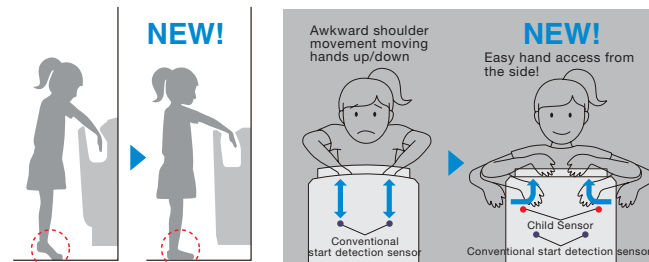

Front panel shape allows hands insertion without standing on toes.

Insert hands from the side to activate Child Sensor for quick drying!

A blue light that creates a feeling of cleanliness and helps in the drying process comes on when hands are placed in the air-drying section. The better visibility during use ensures thorough drying from the wrist to the fingertips.

*1: At least 125cm in height



3 Easy to Clean and Hygienic

Hose-less structure is easy to clean

Cleansable Water Drainage Duct

Eliminating the conventional drain hose, a water drainage duct is built into the unit, located inside the side panel. Cleaning work and post-cleaning inspection are simple and easy; just remove the side cover.



Number of joints halved for improved dirt resistance

Easy-to-Clean Body

The number of joints at the hand insertion section has been reduced, eliminating places where dirt can accumulate, and thereby improving both appearance and hygienic conditions. The new unit design is more dirt-resistant and much easier to clean.

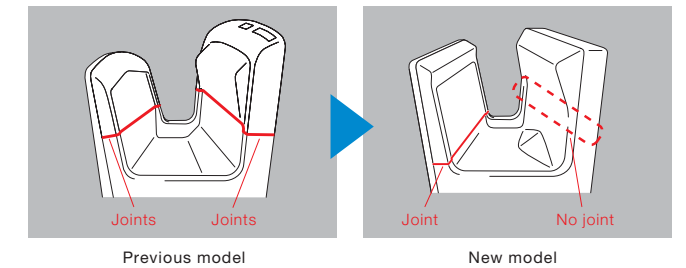

JT-SB216JSH/KSN: Specifications

Model name	Power supply	Model	Heater	Drying time (sec)	Airflow rate (m/s)	Air volume (m³/min)	Rated current (A)	Power consumption (W)	Noise (dB)	Motor type	Safety components	Power cord	External dimensions (mm)	Weight (kg)	Drain tank (L)
JT-SB216JSH	220-240V 50-60Hz	High	ON	9-11	106	3.1	5.7-6.2	1240	61	Brushless DC motor	- Thermal fuse - Overcurrent breaker	None (Terminal block connection)	Width: 300 Depth: 219 Height: 670	11	0.8
		Standard	OFF	11-13	98	2.8	3.9-4.2	720	58						
JT-SB216KSN	220-240V 50-60Hz	-	-	13-15	98	2.8	3.0-3.2	550	58	Brushless DC motor	- Thermal fuse - Overcurrent breaker	None (Terminal block connection)	Width: 300 Depth: 219 Height: 670	11	0.8

*Drying times (remaining moisture of one hand being 50mg or less) obtained using in-house measurement method. *Airflow rate measured at the nozzle outlet.
*Noise measurements performed in an anechoic chamber at a distance of 2m

Outline Drawing JT-SB216JSH/KSN

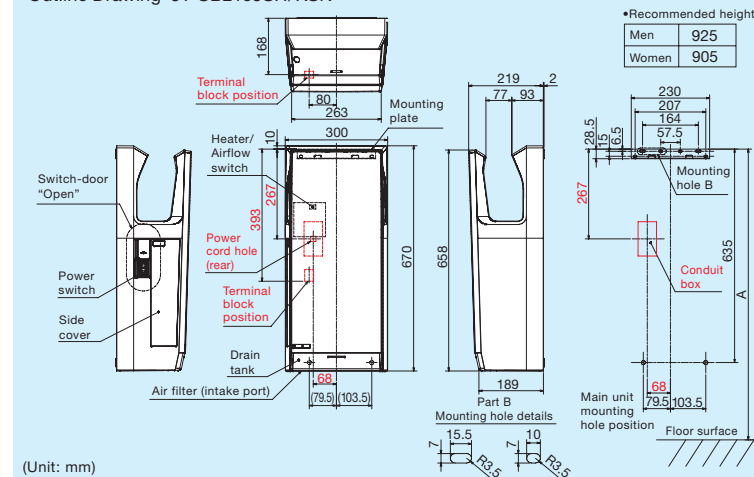

Mounting Diagram JT-SB216JSH/KSN

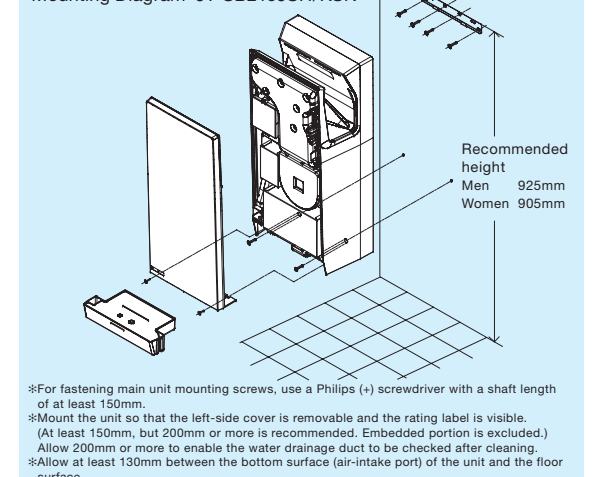

Jet Towel™ Stand

JP-S21FS2-H (Light gray)

Slim Series
JT-SB216JSH/KSN



Outline Drawing JP-S21FS2-H

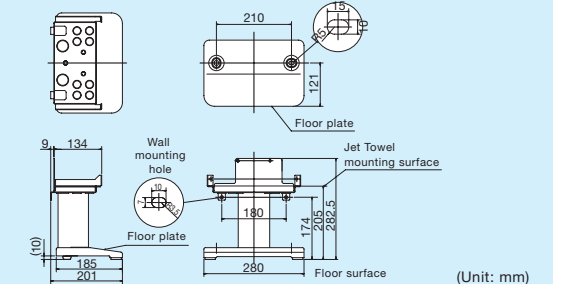

Jet Towel's many benefits make it suitable for a wide range of environments.

Office Building (Genesys Environmental) UK



Low carbon company so chose the product with the lowest consumption to fit into their own offices.

"We reviewed 3 versions of hand dryers and chose the Mitsubishi Jet Towel because of its low noise level and low power consumption. Being a low carbon company, we needed to follow our energy-saving principles. We have put up signs above the Jet Towel which tells users how much energy they are saving by using the product. Previously we used paper towels which often ran out, so there was either nothing to dry hands on, or so many of them were used that the rubbish bins were overflowing. This became unpleasant in a washroom. The Jet Towel has made the washroom area a much nicer environment."

●Factors behind the decision to use the Jet Towel:



- Paper towels seen as unhygienic
- Paper towels often ran out
- Rubbish bins overflowing

Background to Installation	In Use/ Renovated building
Previous drying system	Paper towels
Jet Towel installation sites	Restrooms throughout the facility
Number installed	3 units

Office Building/Museum (California Academy of Sciences) U.S.A.



Provide the public with an environmentally friendly learning center in all facets of operation.

"We found that the Jet Towel is quieter, sleeker in its design and its drying time is quicker than its competitor, not to mention the fact that the Jet Towel offers users a heated stream of air rather than a cold blast. We were actually amazed at how well and how quickly it worked."

●Factors behind the decision to use the Jet Towel:

- The Academy's ongoing commitment to sustainability.
- Quest for LEED certification (LEED Platinum building).
- Reduce paper towel waste.



Installation History	New building
Previous drying system	—
Jet Towel installation sites	Public restrooms throughout the facility

Office Building (Siemens Hearing Instruments) UK



Mess gone. Time saving in not clearing up and no monitoring needed.

"The washrooms are often the first point of call for our visitors. As such we wanted to provide a modern cost effective approach to hand drying for both staff and visitors. We selected the unheated Jet towel for our main washrooms replacing messy paper towels with the obvious benefits to the appearance of our washroom and to the environment in general."

●Factors behind the decision to use the Jet Towel:

Acceptable to use paper towels but very messy Image for customers as first point of call Energy a concern but not the first reason for buying jet towel



Background to Installation	In Use/ Renovated building
Previous drying system	Paper towels
Jet Towel installation sites	Restrooms throughout the facility
Number installed	7 units

Office Building (Shanghai World Financial Center) CHINA



Introduction of the High-speed Hand Dryer to help reduce operating expenses.

"An important consideration in installing the High-speed Hand Dryer was whether it would help reduce our operating expenses. So we installed the High-speed Hand Dryer on a trial basis in an existing building owned by Mori Building and compared the operating costs against those incurred with the use of paper towels. The results highlighted the superior cost performance of the High-speed Hand Dryer, and encouraged us to move ahead with its introduction."

●Factors behind the decision to use the Jet Towel:

- Low operating costs
- Quicker drying through dual-jet airflow
- Hygienic no-contact drying
- Good reliability of the product quality



Background to Installation	New building
Previous drying system	—
Jet Towel installation sites	Restrooms throughout the facility
Number installed	164 units

Commercial Building (Costco) U.S.A.



No more mess in the restrooms. Big savings by eliminating paper towel from budget.

"We tested 2 different types of hand dryers. The Mitsubishi Jet Towel was the best option for our customers. During the trial period, our customers liked the quieter, more approachable looking Mitsubishi Jet Towel over the other types of high speed hand dryers we tested. Customer comments were over-whelmingly positive."

●Factors behind the decision to use the Jet Towel:

Paper towels create an unsightly mess in the restroom. The drain tank eliminates water on the floors and walls around the dryer



Background to Installation	Company-wide warehouse renovation
Previous drying system	Paper towels
Jet Towel installation sites	Restrooms throughout the facility
Number installed	4 per location 4 locations

Hotel (Marina Mandarin) SINGAPORE

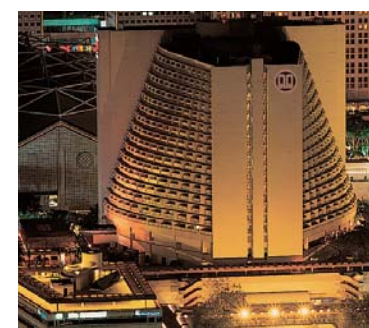

We greatly reduce our maintenance cost with Jet Towel as there's no need for us to replenish paper towels and remove the waste.

"The installation of the Jet Towels in our restrooms helps reduce cleaning and operation costs significantly. It also reduces paper wastage and offers rapid drying for our guests. There is less cumbersome work for our maintenance to replenish paper towels or clear waste. The design of the Jet Towel also blends into the interior design of our restrooms and improves our restroom ambience."

●Factors behind the decision to use the Jet Towel:

- Create a more sanitary environment
- Reflects environmental considerations by reducing paper waste
- Quicker drying through the Dual Jet airflow



Background to Installation	In Use/ Renovated building
Previous drying system	Paper towels
Jet Towel installation sites	Restrooms throughout the facility
Number installed	18 units

Commercial Building (Nordstrom) U.S.A.



Restroom now provide a positive message to our clientele. Customer feedback extremely positive.

"Our customers have clearly shown a preference for environmentally responsible options in the restrooms. Our new restrooms are low-water use, low energy use, and now paper towel free. Before we used the Jet Towel, we avoided hand dryers because of the noise, slipping hazard, and most importantly the frustration caused by the older style of hand dryers. The Jet Towel is now a featured fixture in our restrooms."

●Factors behind the decision to use the Jet Towel:

Nordstrom needed a very quiet hand dryer to maintain pleasant atmosphere in restroom Low energy consumption was a major factor in decision to use the Jet Towel



Background to Installation	Upgrading restrooms to become more eco-friendly
Previous drying system	Paper towels
Jet Towel installation sites	Customer restrooms throughout facility
Number installed	16 per location 4 locations

Office Building / Commercial Facility (Mitsubishi Estate Co., Ltd.) JAPAN

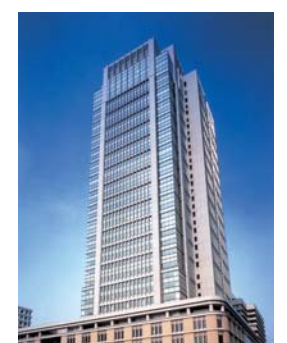

The Jet Towel blends with a wide range of interior design schemes and is perceived as a key restroom amenity.

"New slim-type units were installed in all restrooms in order to blend with the existing interior design. Unlike with paper towels, there's no need to replenish supplies or remove waste, which greatly reduces custodial work. The electric-powered high-speed hand dryers also help to protect the environment by eliminating the use of paper."

●Factors behind the decision to use the Jet Towel:

- Design blends into any space
- Reduced operating and cleaning costs
- Environmentally-friendly waste-free system



Background to Installation	New building
Previous drying system	—
Jet Towel installation sites	Restrooms throughout the facility
Number installed	144 units

The Jet Towel is also providing excellent service in business offices, convention centres, amusement parks, shopping centres, general industrial factories, food plants, precision machinery plants, airports and other locations where large numbers of people gather.